



GLOBALTECH
M A K İ N A



SİLOBAS KOMPRESÖRLERİ VE YEDEK PARÇALARI

BULK TRAILER COMPRESSORS & SPARE PARTS
КОМПРЕССОР ДЛЯ ЦЕМЕНТОВОЗА & ЗАПЧАСТИ

globaltechmak.com



İSTİKRAR

AZİM VE GÜVENİN
Hikayesi

Story of stability, perseverance and trust.

История стабильности, целеустремленности и надежности



Certificate Of Conformity
EN 1012-1:2010 EN ISO 12100:2010



Certificate Of Conformity
EN 1012-1:2010 EN 60204-1:2018
EN ISO 12100:2010



Certificate
TS EN ISO 9001:2015



GLOBALTECH M A K İ N A

HAKKIMIZDA

30 yılı aşkın süredir, ağır vasıta sektöründe faaliyet gösteren şirketimiz, 2017 yılında imalata başlamak adına Globaltech Makina'yı kurdu. Uzun yıllar, sektördeki saha satışlarımızdan edindiğimiz tecrübelerimiz, müşterilerimizin üretim kısmındaki beklenti ve sorunlarına daha hızlı yanıt vermemize yardımcı oldu. Siz değerli dostlarımızın sevgileri ve iş birlikleri sayesinde edinmiş olduğumuz, sektördeki pozisyonumuzun, bilinci ve sorumluluğu bizlerin en önemli motivasyon kaynağıdır.

Globaltech Makina'nın sektörümüze en önemli katma değeri; tüm yatırımlarını üretim ve Ar-Ge'ye yapmayı tercih etmesi, olduğunu düşünüyoruz. Bu anlayıştan hareketle şirketimiz, Konya Organize Sanayi Bölgesinde bulunan 5000 m2 kapalı alana sahip tesisinde, üretim ve stoklama alanlarının yatırımına her geçen gün devam etmektedir. Ayrıca kuruluşumuzdan bu yana kalite ve çevre konusunda yatırımlarımızı ve geliştirmelerimizi sürdürerek

siz saygı değer dostlarımıza en iyi hizmeti vermeye gayret göstermekteyiz.

Globaltech Makina çalışanlarının özverili çalışmaları ve yetenekleri, sizlere sunduğumuz hizmetlerimizdeki başarımızın temel taşıdır. Deneyimli kadromuz disiplinli ve tutarlı çalışmalarının eseri olarak, ürünlerimizin kalitesi, teslimat sürelerimiz ve satış sonrası hizmetlerimizle birlikte, sektöründe sevgi, övgü ve güven kazanmayı başarmıştır. Globaltech Makina yüksek kalite, rekabetçi fiyat ve stoktan teslimatın doğru adresidir. Kurulmaktan bugüne öğrenmeyi ve gelişmeyi hiç bırakmayan firmamız, siz değerli iş ortaklarına daha iyi hizmet verebilmek adına her yıl büyümeyi hedef almaktadır. Yalnızca müşterilerimizin beklentilerine cevap verebilmek için değil, aynı zamanda pazarın gerekliliklerinin de üzerine çıkmak için çalışmalarımıza kararlılıkla devam etmekteyiz.

ABOUT US

Our company, which has been operating in the heavy vehicle sector for more than 30 years, established Globaltech Makina in 2017 to start production. Our experience gained from our field sales in the sector for many years has helped us to respond more quickly to the expectations and problems of our customers in the production part. The awareness and responsibility of our position in the sector, which we have gained thanks to the love and cooperation of you, our dear friends, is the most important source of motivation for us.

The most important added value of Globaltech Makina to our industry; We think that it prefers to make all its investments in production and R&D. Based on this understanding, our company continues to invest in production and storage areas in its 5000 m2 closed area facility located in Konya Organize Industrial Zone. In addition, since our establishment, we have been trying to provide

the best service to you, our esteemed friends, by continuing our investments and developments in quality and environment.

The devoted work and talents of Globaltech Makina employees are the cornerstones of our success in the services we offer you. As a result of our disciplined and consistent work, our experienced staff has managed to win love, praise and trust in the industry, together with the quality of our products, delivery times and after-sales services. Globaltech Makina is the right address for high quality, competitive price and stock delivery. Our company, which has never stopped learning and developing since its establishment, aims to grow every year in order to provide better service to you, our valuable business partners. We continue our work with determination not only to meet the expectations of our customers, but also to exceed the requirements of the market.

О КОМПАНИИ

Наша компания, более 30 лет работающая в сфере грузовых автомобилей, в 2017г. основала Globaltech Makina с целью начать производство. Опыт, полученный нами на протяжении многих лет в сфере продаж в этой отрасли, помогает нам быстро и четко реагировать на ожидания и потребности наших клиентов, а также решать вопросы, возникающие в производственной части. Ответственность и осознание нашего положения в данной отрасли, которое мы получили благодаря признательности и сотрудничеству с Вами, наши дорогие друзья, является для нас важнейшим источником мотивации.

Самым главным вкладом компании Globaltech Makina в развитие сектора мы считаем направление инвестиций в производство, исследование и разработку. Основываясь на этом, наша компания продолжает инвестировать в производственные и складские помещения, находящиеся на ее собственном объекте площадью 5000м2, расположенном в Специальной промышленной зоне г. Конья. Кроме того, с момента нашего основания мы стараемся предоставить вам наилучшие услуги,

наши уважаемые друзья, продолжая наши инвестиции и разработки в области качества и окружающей среды.

Самоотверженная работа и талант сотрудников Globaltech Makina являются ключевым моментом нашего успеха в предоставлении Вам услуг. В результате своей дисциплинированной и последовательной работы нашим опытным сотрудникам, наряду с качеством нашей продукции, сроками поставки и послепродажным обслуживанием, удалось завоевать любовь, похвалу и доверие в своей отрасли. Globaltech Makina — это правильный адрес для высокого качества, конкурентоспособной цены и наличия на складе.

Наша компания, непрерывно развивающаяся с момента своего основания, и сегодня неизменно в своем стремлении расти с каждым годом, чтобы предоставлять Вам, нашим глубоко уважаемым деловым партнерам, качественные услуги. Мы продолжаем упорно работать, чтобы не только оправдать ожидания наших клиентов, но и отвечать на достойном уровне требованиям рынка.



İÇİNDEKİLER

5 TABLE OF CONTENTS | СОДЕРЖАНИЕ

2 -3

HAKKIMIZDA/ ABOUT US / О КОМПАНИИ

4- 5

İÇİNDEKİLER / TABLE OF CONTENTS / СОДЕРЖАНИЕ

6-7

G220-2 PİSTONLU SİLOBAS KOMPRESÖRLERİ | BULK TRAILER COMPRESSORS | ПОРШНЕВОЙ КОМПРЕССОР ДЛЯ ЦЕМЕНТОВОЗА

8-9

G160-3 PİSTONLU SİLOBAS KOMPRESÖRLERİ | BULK TRAILER COMPRESSORS | ПОРШНЕВОЙ КОМПРЕССОР ДЛЯ ЦЕМЕНТОВОЗА

10

YAĞSIZ VİDALI SİLOBAS KOMPRESÖRÜ | OIL FREE SCREW TYPE BULK TRAILER COMPRESSOR | БЕЗМАСЛЯНЫЙ ВИНТОВОЙ КОМПРЕССОР ДЛЯ ЦЕМЕНТОВОЗА

11-12-13

G220-2 YEDEK PARÇA | SPARE PARTS | ЗАПАСНЫЕ ЧАСТИ

14-15-16

G160-3 YEDEK PARÇA | SPARE PARTS | ЗАПАСНЫЕ ЧАСТИ

17

SİLOBAS AKS. VE YEDEK PARÇA | BULK TRAILER ACC. AND SPARE PARTS | ЗАПЧАСТИ И АКСЕССУАРЫ ДЛЯ ЦЕМЕНТОВОЗА

18

DİZEL MOTOR YEDEK PARÇA | DIESEL ENGINE SPARE PARTS | ДИЗЕЛЬНЫЙ ДВИГАТЕЛЬ И ЗАПАСНЫЕ ЧАСТИ

19

ELEKTRİK MOTOR YEDEK PARÇA | ELECTRICAL ENGINE SPARE PARTS | ЭЛЕКТРОДВИГАТЕЛЬ И ЗАПАСНЫЕ ЧАСТИ



KULLANIM KILAVUZU | USER GUIDE
РУКОВОДСТВО ПОЛЬЗОВАТЕЛЯ

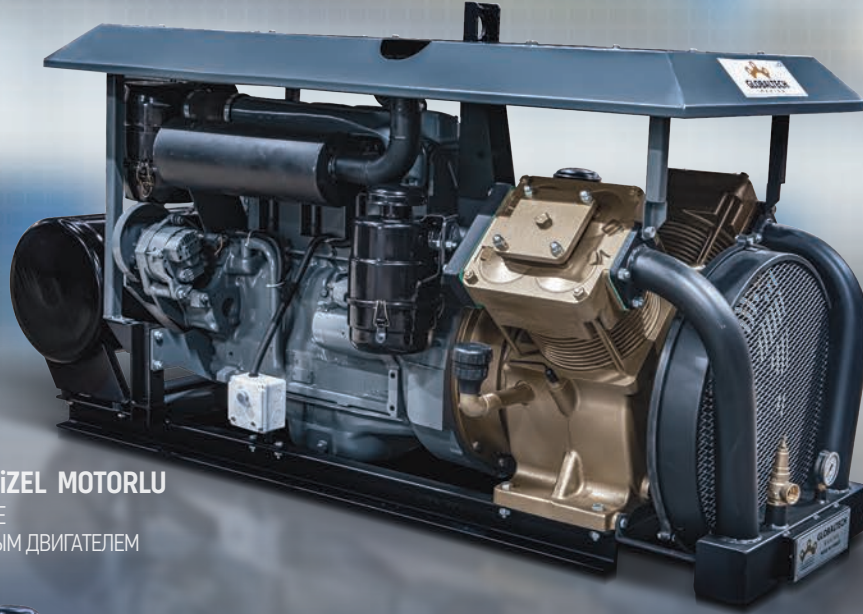

G220-2 YENİLENMİŞ DİZEL MOTORLU
RE-NEWED DIESEL ENGINE
С ОБНОВЛЕННЫМ ДИЗЕЛЬНЫМ ДВИГАТЕЛЕМ

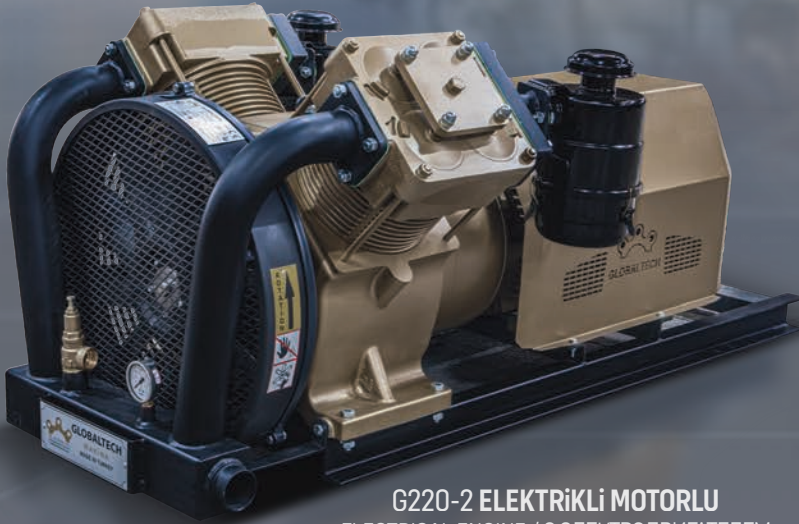

G220-2 ELEKTRİKLİ MOTORLU
ELECTRICAL ENGINE / С ЭЛЕКТРОДВИГАТЕЛЕМ

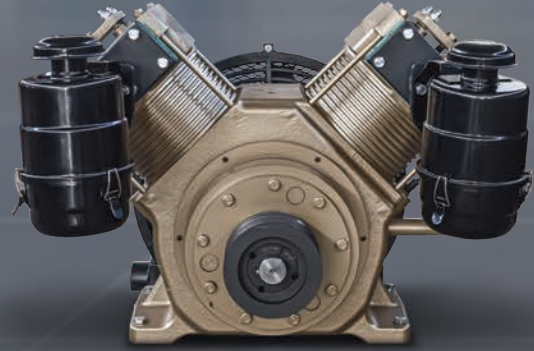

G220-2 KASNAKLI
COMPRESSOR WITH PULLEY / СО ШКИВОМ

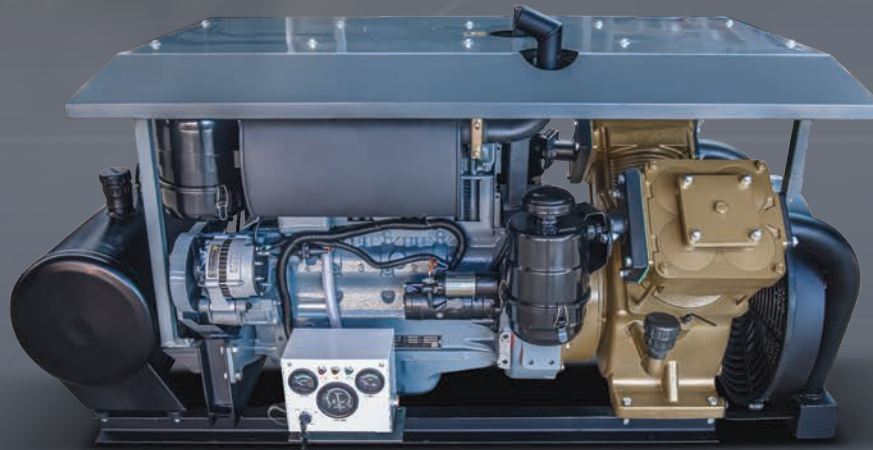

G220-2 YENİ DİZEL MOTORLU
NEW DIESEL ENGINE / С НОВЫМ ДИЗЕЛЬНЫМ ДВИГАТЕЛЕМ

G220-2 TEKNİK ÖZELLİKLER | TECHNICAL SPECIFICATIONS | ТЕХНИЧЕСКИЕ ХАРАКТЕРИСТИКИ

MODEL / МОДЕЛЬ	G220-2-E22-P	G220-2-E30-P	G220-2-BDM	G220-2-DDM	G220-2-KSK KASNAKLI KOMPRESÖR PULLEY / СО ШКИВОМ
MOTOR TİPİ ENGINE TYPE ТИП ДВИГАТЕЛЯ	ELEKTRİK ELECTRICAL	ELEKTRİK ELECTRICAL	YENİ DİZEL MOTOR NEW DIESEL ENGINE НОВЫЙ ДИЗЕЛЬ	YENİLENMİŞ DİZEL MOTOR RE-NEWED DIESEL ENGINE ОБНОВЛЕННЫЙ ДИЗЕЛЬНЫЙ	-
DEBİ (LT/DK) FLOW (LT / MIN) ЛТ (МИН)	10.200	10.200	10.200	10.200	10.200
DEVİR (D/DK) RPM (RPM/MIN) ПЕРЕДАЧА (ОБ/МИН)	1500	1500	1500	1500	1500
BASINÇ (BAR) PRESSURE (BAR) ДАВЛЕНИЕ (БАР)	2,0 - 3,5	2,0 - 3,5	2,0 - 3,5	2,0 - 3,5	2,0 - 3,5
GÜÇ (KW/HP) POWER / МОЩНОСТЬ	22 / 30	30 / 40	59 / 80	59 / 80	-
PİSTON ÇAPİ (MM) PISTON DIAMETER (MM / PCS) ДИАМЕТР ПОРШНЯ (ММ /ШТ)	220 * 2	220 * 2	220 * 2	220 * 2	220 * 2
AĞIRLIK (KG) WEIGHT (KG) / ВЕС (КГ)	580	652	801	790	355
ÖLÇÜLER (CM) (EN * BOY * YÜKSEKLİK) DIMENSIONS (CM) (WIDTH * LENGTH * HEIGHT) РАЗМЕРЫ (CM) (ШИРИНА, ДЛИНА, ВЫСОТА)	95 * 170 * 72	90 * 200 * 90	90 * 200 * 100	90 * 90 * 80	90 * 90 * 80

► **G220-2 ELEKTRİKLI MOTORLU**
ELECTRICAL ENGINE / С ЭЛЕКТРОДВИГАТЕЛЕМ

► **G220-2 YENİ DİZEL MOTORLU**
NEW DIESEL ENGINE / С НОВЫМ ДИЗЕЛЬНЫМ ДВИГАТЕЛЕМ

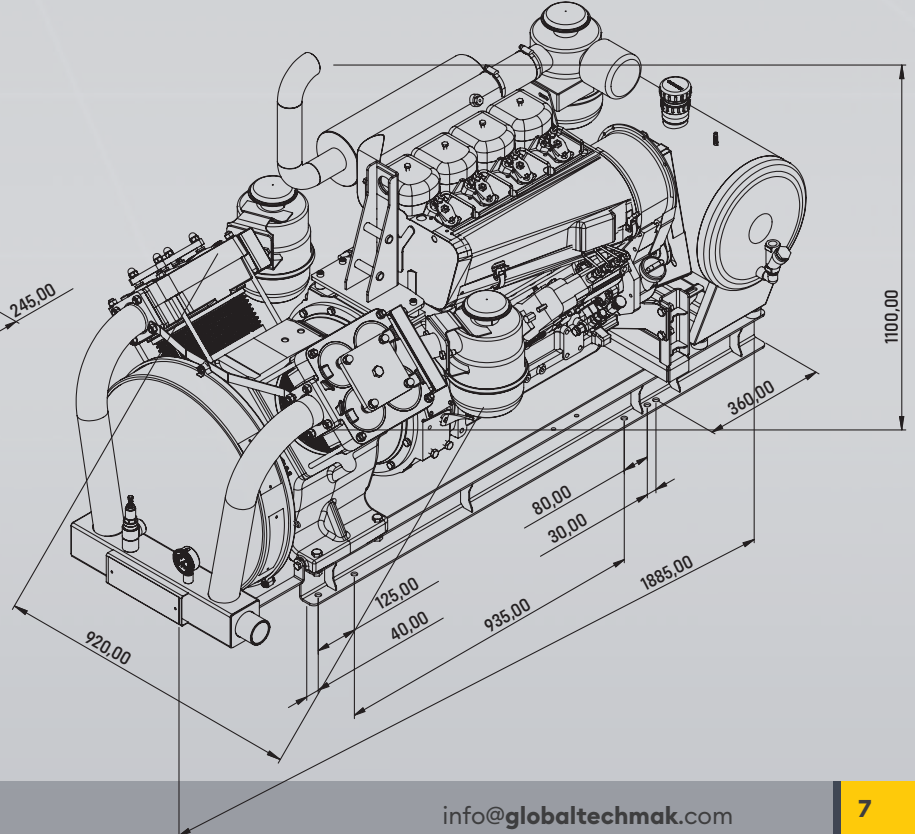
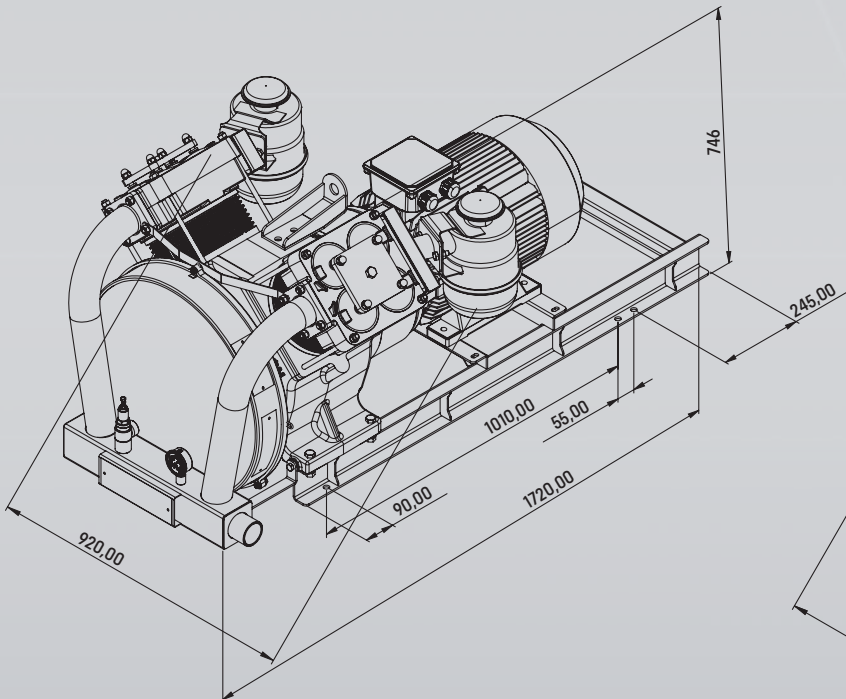

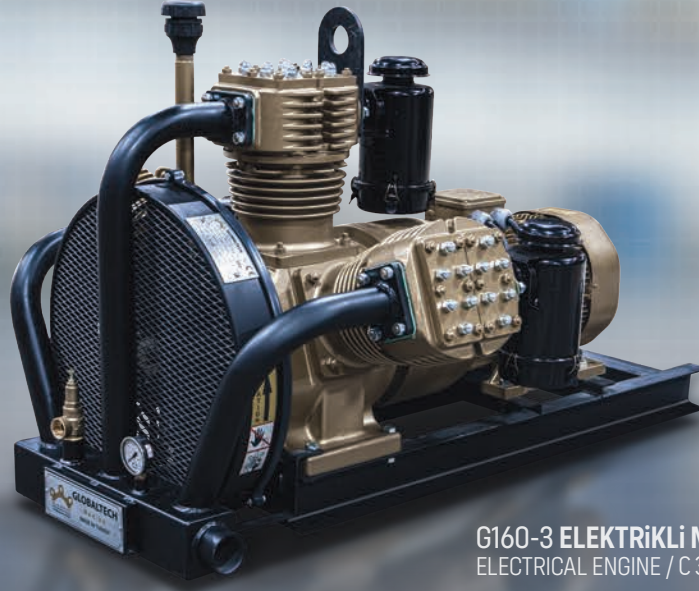

G160-3 ELEKTRİKLI MOTORLU
ELECTRICAL ENGINE / С ЭЛЕКТРОДВИГАТЕЛЕМ

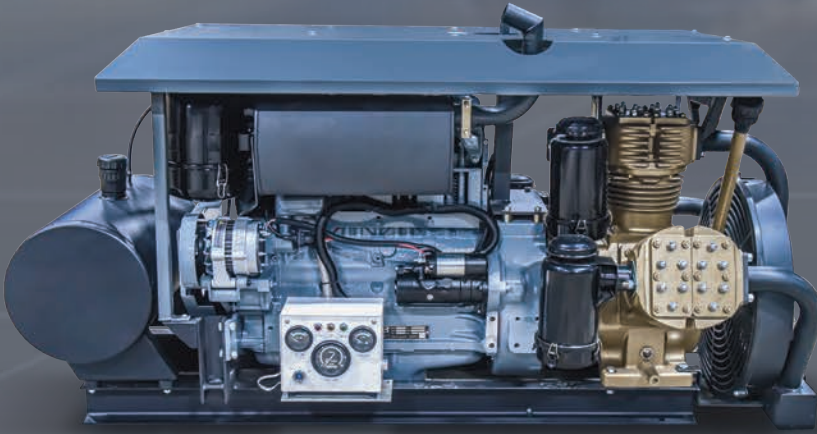

G160-3 YENİ DİZEL MOTORLU
NEW DIESEL ENGINE / С НОВЫМ ДИЗЕЛЬНЫМ ДВИГАТЕЛЕМ



G160-3 KOMPRESÖR (MOTORSUZ)
COMPRESSOR (WITHOUT ENGINE)
КОМПРЕССОР (БЕЗ ДВИГАТЕЛЯ)

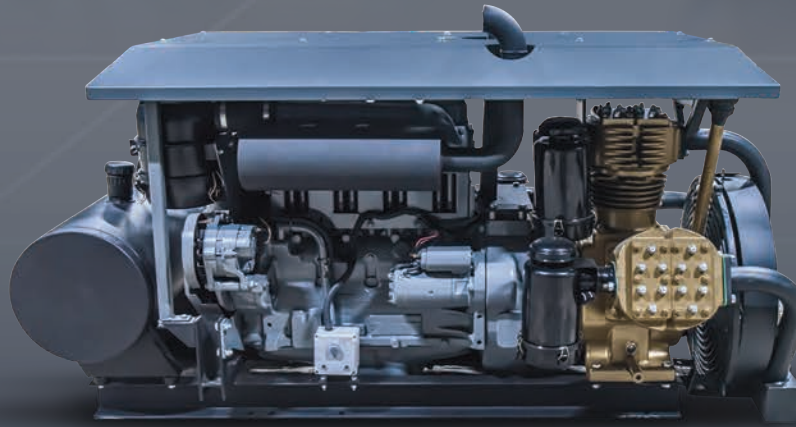

G160-3 YENİLENMİŞ DİZEL MOTORLU
RE-NEWED DIESEL ENGINE
С ОБНОВЛЕННЫМ ДИЗЕЛЬНЫМ ДВИГАТЕЛЕМ

G160-3 TEKNİK ÖZELLİKLER | TECHNICAL SPECIFICATIONS | ТЕХНИЧЕСКИЕ ХАРАКТЕРИСТИКИ

MODEL / МОДЕЛЬ	G160-3-E18-P	G160-3-BDM	G160-3-DDM	G160-3-KSK KASNAKLI KOMPRESÖR PULLEY / СО ШКИВОМ
MOTOR TİPİ ENGINE TYPE ТИП ДВИГАТЕЛЯ	ELEKTRİK ELECTRICAL ЭЛЕКТРИЧЕСКИЙ	YENİ DİZEL MOTOR NEW DIESEL ENGINE НОВЫЙ ДИЗЕЛЬ	YENİLENMİŞ DİZEL MOTOR RE-NEWED DIESEL ENGINE ОБНОВЛЕННЫЙ ДИЗЕЛЬНЫЙ	-
DEBİ (LT/DK) FLOW (LT / MIN) ЛТ (МИН)	7200	7200	7200	7200
DEVİR (D/DK) RPM (RPM/MIN) ПЕРЕДАЧА (ОБ/МИН)	1500	1500	1500	1500
BASINÇ (BAR) PRESSURE (BAR) ДАВЛЕНИЕ (БАР)	2,0 - 3,5	2,0 - 3,5	2,0 - 3,5	2,0 - 3,5
GÜÇ (KW/HP) POWER / МОЩНОСТЬ	18,5 / 25	59 / 80	59 / 80	-
PİSTON ÇAPİ (MM) PISTON DIAMETER (MM / PCS) ДИАМЕТР ПОРШНЯ (ММ / ШТ)	160 * 3	160 * 3	160 * 3	160 * 3
AĞIRLIK (KG) WEIGHT (KG) / ВЕС (КГ)	325	740	740	304
ÖLÇÜLER (CM) (EN * BOY * YÜKSEKLİK) DIMENSIONS (CM) (WIDTH * LENGTH * HEIGHT) РАЗМЕРЫ (СМ) (ШИРИНА, ДЛИНА, ВЫСОТА)	100 * 142 * 95	95 * 210 * 95	95 * 210 * 95	-

► G160-3 YENİ DİZEL MOTORLU
NEW DIESEL ENGINE / С НОВЫМ ДИЗЕЛЬНЫМ ДВИГАТЕЛЕМ

► G160-3 ELEKTRİKLI MOTORLU
ELECTRICAL ENGINE / С ЭЛЕКТРОДВИГАТЕЛЕМ

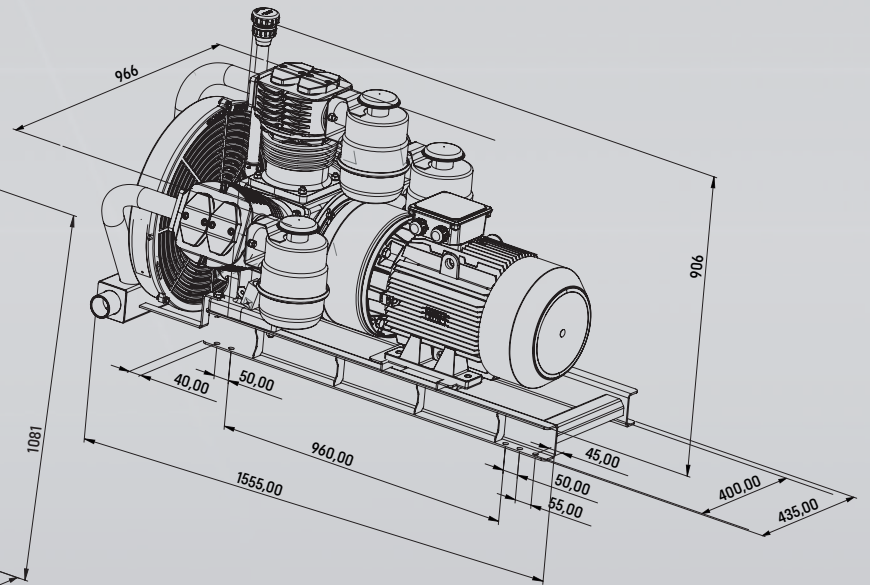
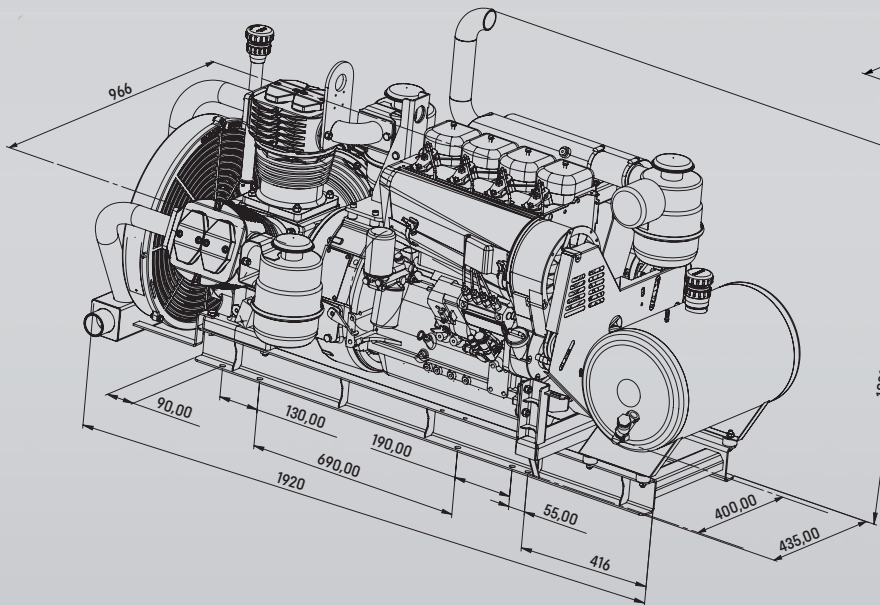

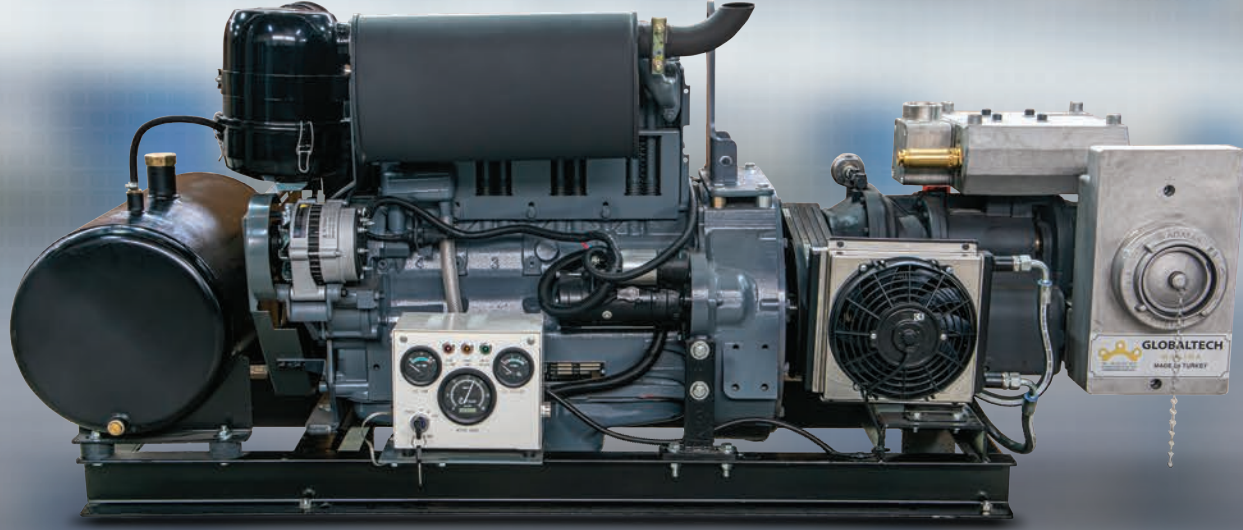







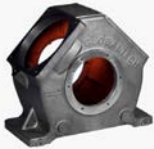





























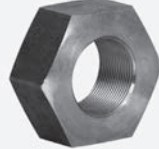

TEKNİK ÖZELLİKLER | TECHNICAL SPECIFICATIONS | ТЕХНИЧЕСКИЕ ХАРАКТЕРИСТИКИ



















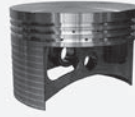

MODEL / МОДЕЛЬ	E30 G411030002	BDM G411030001
MOTOR TİPİ ENGINE TYPE ТИП ДВИГАТЕЛЯ	ELEKTRİK / ELECTRICAL ЭЛЕКТРИЧЕСКИЙ	YENİ DİZEL / NEW DIESEL НОВЫЙ ДИЗЕЛЬ
DEBİ (LT/DK) FLOW (LT / MIN) ЛТ (МИН)	7200 LT - 10.200 LT	7200 LT - 10.200 LT
DEVİR (D/DK) RPM (RPM/MIN) ПЕРЕДАЧА (ОБ/МИН)	3000 RPM - 3600 RPM	3000 RPM - 3600 RPM
BASINÇ (BAR) PRESSURE (BAR) ДАВЛЕНИЕ (БАР)	2,0	2,0
GÜÇ (KW/HP) POWER / МОЩНОСТЬ	30 KW - 40 HP	59 KW - 80 HP
PİSTON ÇAPİ (MM) PISTON DIAMETER (MM / PCS) ДИАМЕТР ПОРШНЯ (ММ /ШТ)	-	-
AĞIRLIK (KG) WEIGHT (KG) / ВЕС (КГ)	700	700
ÖLÇÜLER (CM) (EN * BOY * YÜKSEKLİK) DIMENSIONS (CM) (WIDTH * LENGTH * HEIGHT) РАЗМЕРЫ (CM) (ШИРИНА, ДЛИНА, ВЫСОТА)	-	-

















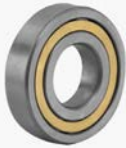

G220-2 | YEDEK PARÇA | SPARE PARTS | ЗАПАСНЫЕ ЧАСТИ

<p>G303010001</p>  <p>KARTER OIL HOUSING КАРТЕР</p>	<p>G303020004</p>  <p>KRANK CRANK КОЛЕНВАЛ</p>	<p>G303020006</p>  <p>BİYEL KOLU CONNECTING ROD ШАТУН</p>	<p>G113010007</p>  <p>NKJS 70 A RULMAN NKJS 70 A BEARING ПОДШИПНИК NKJS 70 A</p>
<p>G113010003</p>  <p>RNA6905 RULMAN BEARING RNA6905 ПОДШИПНИК RNA6905</p>	<p>G303020005</p>  <p>KRANK AĞIRLIĞI CRANK BALANCE PLATE ВЕС КОЛЕНЧАТОГО ВАЛА</p>	<p>G303010008</p>  <p>ARKA KAPAK REAR COVER ЗАДНЯЯ КРЫШКА</p>	<p>G114010010</p>  <p>ARKA KAPAK SEGMANI REAR COVER RING КОЛЬЦО ЗАДНЕЙ КРЫШКИ</p>
<p>G113010017</p>  <p>N311 ARKA KAPAK RULMANI N311 REAR COVER BEARING ПОДШИПНИК ЗАДНЕЙ КРЫШКИ N311</p>	<p>G303010007</p>  <p>ÖN KAPAK FRONT COVER ПЕРЕДНЯЯ КРЫШКА</p>	<p>G114010005</p>  <p>ÖN KAPAK SEGMANI FRONT COVER RING КОЛЬЦО ПЕРЕДНЕЙ КРЫШКИ</p>	<p>G113010020</p>  <p>NUP311 ÖN KAPAK RULMANI NUP311 FRONT COVER BEARING ПОДШИПНИК ПЕРЕДНЕЙ КРЫШКИ NUP311</p>
<p>G109030001</p>  <p>KRANK YAĞ KEÇESİ CRANK OIL SEAL САЛЬНИК</p>	<p>G303010009</p>  <p>KRANK ÖN KEÇE YATAĞI CRANK FRONT SEAL BEARING ПЕРЕДНЕЕ ВОЙЛОЧНОЕ КОЛЬЦО (МАЛЕНЬКОЕ)</p>	<p>G303010032</p>  <p>KRANK ARKA KEÇE YATAĞI CRANK REAR SEAL BEARING ЗАДНЕЕ ВОЙЛОЧНОЕ КОЛЬЦО (БОЛЬШОЕ)</p>	<p>G119010004</p>  <p>PISTON PİMİ PISTON PIN ПОРШНЕВОЙ ШТИФТ</p>
<p>G114010009</p>  <p>PISTON SEGMANI PISTON RING ПОРШНЕВОЕ КОЛЬЦО</p>	<p>G303010003</p>  <p>GÖMLEK SLEEVE ЦИЛИНДР</p>	<p>G108040006</p>  <p>GÖMLEK SAPLAMA SLEEVE BOLT ШПИЛЬКА ЦИЛИНДРА</p>	<p>G303010004</p>  <p>HAVA EMME BLOĞU AIR INTAKE BLOCK ВСАСЫВАЮЩИЙ БЛОК ВОЗДУХА</p>

















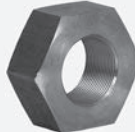

<p>G108030017</p>  <p>KLAPE BAKIR PUL FLAP COPPER WASHER МЕДНАЯ ШАЙБА КЛАПАНА</p>	<p>G303020023</p>  <p>HAVA EMME KLAPE SUCTION VALVE ВСАСЫВАЮЩИЙ ВОЗДУШНЫЙ КЛАПАН</p>	<p>G303020024</p>  <p>HAVA BASMA KLAPE PRESSURE VALVE ВПУСКНОЙ ВОЗДУШНЫЙ КЛАПАН</p>	<p>G303030001</p>  <p>KLAPE KAFESİ ALUMINYUM UZUN VALVE CAP ALUMINUM LONG КЛЕТКА ДЛЯ КЛАПАНОВ АЛЮМИНИЕВАЯ ДЛИННАЯ</p>
<p>G303030002</p>  <p>KLAPE KAFESİ ALUMINYUM KISA VALVE CAP ALUMINUM SHORT КЛЕТКА ДЛЯ КЛАПАНОВ АЛЮМИНИЕВАЯ КОРОТКАЯ</p>	<p>G109020001</p>  <p>KAFES ORİNGİ VALVE CAP O-RING КРЫШКА КЛЕТКИ</p>	<p>G301060090</p>  <p>KAFES ORİNGİ VALVE CAP BRACKET КРЫШКА КЛЕТКИ</p>	<p>G108140001</p>  <p>KRANK KAMASI CRANK SAFETY PIN ШТИФТ КОЛЕНЧАТОГО ВАЛА</p>
<p>G303010010</p>  <p>KONİK VOLANT FLYWHEEL КОНИЧЕСКИЙ МАХОВИК</p>	<p>G302020004</p>  <p>KONİK VOLANT PİMİ COUPLING PIN КОНИЧЕСКИЙ ШТИФТ МАХОВИКА</p>	<p>G105020004</p>  <p>PİM LASTİĞİ COUPLING PIN RUBBER ШТИФТ ШИНЫ</p>	<p>G302010002</p>  <p>KRANK SOMUNU CRANK NUT КОЛЕНЧАТАЯ ГАЙКА</p>
<p>G303010024</p>  <p>DİZEL KOMPRESÖR MUHAFAZA DIESEL COMPRESSOR HOUSING КОРПУС ДИЗЕЛЬНОГО КОМПРЕССОРА</p>	<p>G301070023</p>  <p>YAĞ GÖSTERGE ÇUBUĞU OIL LEVELLER ИНДИКАТОР МАСЛА</p>	<p>G301070001</p>  <p>RADYATÖR RADIATOR РАДИАТОР</p>	<p>G305010001</p>  <p>FAN FAN ВЕНТИЛЯТОР</p>
<p>G116010001</p>  <p>MANOMETRE PRESSURE GAUGE МАНОМЕТР</p>	<p>G116010002</p>  <p>EMNİYET VENTİLİ SAFETY VALVE ПРЕДОХРАНИТЕЛЬНЫЙ КЛАПАН</p>	<p>G305010002</p>  <p>KOMPRESÖR YAĞ KARAĞI COMPRESSOR OIL CAP МАСЛЯНАЯ КРЫШКА КОМПРЕССОРА</p>	<p>G305010003</p>  <p>DEPO YAKIT KARAĞI FUEL CAP КРЫШКА БАКА</p>

















G220-2 | YEDEK PARÇA | SPARE PARTS | ЗАПАСНЫЕ ЧАСТИ























<p>G303010025</p>  <p>ELEKTRİKLİ MOTOR KAPLİN ELECTRIC MOTOR COUPLING МУФТА ЭЛЕКТРОДВИГАТЕЛЯ</p>	<p>G303010023</p>  <p>ELEKTRİKLİ MOTOR KAPLİN MUHAFAZA ELECTRIC MOTOR COUPLING HOUSING КОРПУС МУФТЫ ЭЛЕКТРОДВИГАТЕЛЯ</p>	<p>G301070008</p>  <p>FİLTRE KUTUSU SOL FILTER BRACKET LEFT ФИЛЬТР-БОКС СЛЕВА</p>	<p>G301070007</p>  <p>FİLTRE KUTUSU SAĞ FILTER BRACKET RIGHT ФИЛЬТР-БОКС СПРАВА</p>	<p>G115010001</p>  <p>KOMPRESÖR HAVA FİLTRESİ COMPRESSOR AIR FILTER ВОЗДУШНЫЙ ФИЛЬТР КОМПРЕССОРА</p>
<p>G101060004</p>  <p>YAKIT DEPOSU FUEL TANK ТОПЛИВНЫЙ БАК</p>	<p>G108090001</p>  <p>PİSLİK TUTUCU LINE FILTER ДЕРЖАТЕЛЬ</p>	<p>G303010026</p>  <p>DİZEL MOTOR KAPLİN DIESEL ENGINE COUPLING МУФТА ДИЗЕЛЬНОГО ДВИГАТЕЛЯ</p>	<p>G105020011</p>  <p>KOMPRESÖR HAVA FİLTRESİ ÇEVRE LASTİK CONTA COMPRESSOR AIR FILTER ENVIRONMENT RUBBER GASKET КОМПРЕССОР ВОЗДУШНЫЙ ФИЛЬТР ОКРУЖАЮЩАЯ СРЕДА РЕЗИНОВАЯ ПРОКЛАДКА</p>	<p>G105020012</p>  <p>KOMPRESÖR HAVA FİLTRESİ GÖBEK LASTİK CONTA COMPRESSOR AIR FILTER HUB RUBBER GASKET СРЕДНЯЯ РЕЗИНОВАЯ ПРОКЛАДКА ВОЗДУШНОГО ФИЛЬТРА КОМПРЕССОРА</p>
<p>G109010013</p>  <p>CONTA TAKIMI GASKET KIT КОМПЛЕКТ ПРОКЛАДОК</p>	<p>G119010001</p>  <p>PİSTON PISTON ПОРШЕНЬ</p>	<p>G109020002</p>  <p>GÖMLEK ALT O-RİNG SLEEVE LOWER O-RING ЦИЛИНДР НИЖНИЙ ОРИНГ.</p>	<p>G109020003</p>  <p>GÖMLEK ÜST O-RİNG SLEEVE TOP O-RING ОРИНГ ВЕРХНЕЙ ЧАСТИ ЦИЛИНДРА.</p>	<p>G304120002</p>  <p>ELEKTRİK PANOSU 22 KW ELECTRICAL PANEL 22 KW ЭЛЕКТРИЧЕСКАЯ ПАНЕЛЬ 22 КВТ</p>
<p>G104020001</p>  <p>ŞALTER KONTAK TRİFAZE SWITCH CONTACT THREE PHASE КОНТАКТ ПЕРЕКЛЮЧАТЕЛЯ ТРЕХФАЗНЫЙ</p>	<p>G104020002</p>  <p>ŞALTER KONTAK YILDIZ ÜÇGEN SWITCH CONTACT STAR TRIANGLE ПЕРЕКЛЮЧАТЕЛЬ КОНТАКТ ЗВЕЗДА ТРЕУГОЛЬНИК</p>	<p>G301070022</p>  <p>TENTE SACI AWNING SHEET IRON ТЕНТОВЫЙ ЛИСТ</p>	<p>G304120003</p>  <p>ELEKTRİK PANOSU 30KW ELECTRICAL PANEL 30 KW ЭЛЕКТРИЧЕСКАЯ ПАНЕЛЬ 30 КВТ</p>	<p>G104020003</p>  <p>EMNİYET SALTERİ SAFETY SWITCH ПРЕДОХРАНИТЕЛЬНЫЙ ВЫКЛЮЧАТЕЛЬ</p>
<p>G301070034</p>  <p>DİZEL ŞASE DIESEL CHASSIS ШАССИ ДИЗЕЛЬНОГО КОМПРЕССОРА</p>	<p>G301070031</p>  <p>ELEKTRİKLİ ŞASE ELECTRIC CHASSIS ШАССИ ЭЛЕКТРИЧЕСКОГО КОМПРЕССОРА</p>			

























<p>G303010013</p>  <p>KARTER OIL HOUSING КАРТЕР</p>	<p>G303020014</p>  <p>KRANK CRANK КОЛЕНВАЛ</p>	<p>G303020016</p>  <p>BİYEL KOLU CONNECTING ROD ШАТУН</p>	<p>G113010004</p>  <p>NKJS 60 A RULMAN NKJS 60 A BEARING ПОДШИПНИК NKJS 60 A</p>
<p>G303020015</p>  <p>KRANK AĞIRLIĞI CRANK BALANCE PLATE ВЕС КОЛЕНЧАТОГО ВАЛА</p>	<p>G303010021</p>  <p>ARKA KAPAK REAR COVER ЗАДНЯЯ КРЫШКА</p>	<p>G114010004</p>  <p>ARKA KAPAK SEGMANI REAR COVER RING КОЛЬЦО ЗАДНЕЙ КРЫШКИ</p>	<p>G113010010</p>  <p>N309 ARKA KAPAK RULMANI N309 REAR COVER BEARING ПОДШИПНИК ЗАДНЕЙ КРЫШКИ N309</p>
<p>G303010020</p>  <p>ÖN KAPAK FRONT COVER ПЕРЕДНЯЯ КРЫШКА</p>	<p>G114010003</p>  <p>ÖN KAPAK SEGMANI FRONT COVER RING КОЛЬЦО ПЕРЕДНЕЙ КРЫШКИ</p>	<p>G113010013</p>  <p>NUP309 ÖN KAPAK RULMANI NUP309 FRONT COVER BEARING ПОДШИПНИК ПЕРЕДНЕЙ КРЫШКИ NUP309</p>	<p>G109030002</p>  <p>KRANK YAĞ KEÇESİ CRANK OIL SEAL САЛЬНИК</p>
<p>G303010030</p>  <p>KRANK ÖN KEÇE YATAĞI CRANK FRONT SEAL BEARING ПЕРЕДНЕЕ ВОЙЛОЧНОЕ КОЛЬЦО (МАЛЕНЬКОЕ)</p>	<p>G303010031</p>  <p>KRANK ARKA KEÇE YATAĞI CRANK REAR SEAL BEARING ЗАДНЕЕ ВОЙЛОЧНОЕ КОЛЬЦО (БОЛЬШОЕ)</p>	<p>G119010003</p>  <p>PISTON PISTON ПОРШЕНЬ</p>	<p>G119010005</p>  <p>PISTON PİMİ PISTON PIN ПОРШНЕВОЙ ШТИФТ</p>
<p>G114010008</p>  <p>PISTON SEGMANI PISTON RING ПОРШНЕВОЕ КОЛЬЦО</p>	<p>G303010014</p>  <p>GÖMLEK SLEEVE ЦИЛИНДР</p>	<p>G113010024</p>  <p>BİYEL KOL BURCU CONNECTING ROD BUSH ВТУЛКА ШАТУНА</p>	<p>G303010016</p>  <p>HAVA EMME BLOĞU SAĞ AIR INTAKE BLOCK RIGHT ВСАСЫВАЮЩИЙ БЛОК ВОЗДУХА СПРАВА</p>

G160-3 | YEDEK PARÇA | SPARE PARTS | ЗАПАСНЫЕ ЧАСТИ

<p>G303010017</p>  <p>HAVA EMME BLOĞU SOL AIR INTAKE BLOCK LEFT ВСАСЫВАЮЩИЙ ВОЗДУХА СЛЕВА</p>	<p>G303010015</p>  <p>HAVA EMME BLOĞU ORTA AIR INTAKE BLOCK MIDDLE ВСАСЫВАЮЩИЙ БЛОК ВОЗДУХА СРЕДНИЙ</p>	<p>G108030016</p>  <p>KLAPE BAKIR PUL FLAP COPPER WASHER МЕДНАЯ ШАЙБА КЛАПАНА</p>	<p>G303020021</p>  <p>HAVA EMME KLAPE SUCTION VALVE ВСАСЫВАЮЩИЙ ВОЗДУШНЫЙ КЛАПАН</p>
<p>G303020022</p>  <p>HAVA BASMA KLAPE PRESSURE VALVE ВПУСКНОЙ ВОЗДУШНЫЙ КЛАПАН</p>	<p>G108140001</p>  <p>KRANK KAMASI CRANK SAFETY PIN ШТИФТ КОЛЕНЧАТОГО ВАЛА</p>	<p>G303010010</p>  <p>KONİK VOLANT FLYWHEEL КОНИЧЕСКИЙ МАХОВИК</p>	<p>G302020004</p>  <p>KONİK VOLANT PİMİ COUPLING PIN КОНИЧЕСКИЙ ШТИФТ МАХОВИКА</p>
<p>G105020004</p>  <p>PİM LASTİĞİ COUPLING PIN RUBBER СОЕДИНИТЕЛЬНЫЙ ШТИФТ РЕЗИНОВЫЙ</p>	<p>G302010001</p>  <p>KRANK SOMUNU CRANK NUT КОЛЕНЧАТАЯ ГАЙКА</p>	<p>G108070007</p>  <p>KOMPRESÖR YAĞ GÖSTERGESİ COMPRESSOR OIL GAUGE ИНДИКАТОР МАСЛА</p>	<p>G301070010</p>  <p>RADYATÖR RADIATOR РАДИАТОР</p>
<p>G305010001</p>  <p>FAN FAN ВЕНТИЛЯТОР</p>	<p>G116010001</p>  <p>MANOMETRE PRESSURE GAUGE МАНОМЕТР</p>	<p>G116010002</p>  <p>EMNİYET VENTİLİ SAFETY VALVE ПРЕДОХРАНИТЕЛЬНЫЙ КЛАПАН</p>	<p>G305010002</p>  <p>KOMPRESÖR YAĞ KAPAĞI COMPRESSOR OIL CAP КРЫШКА КОМПРЕССОРНОГО МАСЛА</p>
<p>G305010003</p>  <p>DEPO YAKIT KAPAĞI FUEL CAP КРЫШКА ТОПЛИВНОГО БАКА</p>	<p>G303010025</p>  <p>ELEKTRİKLİ MOTOR KAPLIN ELECTRIC MOTOR COUPLING МУФТА ЭЛЕКТРОДВИГАТЕЛЯ</p>	<p>G303010023</p>  <p>ELEKTRİKLİ MOTOR KAPLIN MUHAFAZA ELECTRIC MOTOR COUPLING HOUSING КОРПУС МУФТЫ ЭЛЕКТРОДВИГАТЕЛЯ</p>	<p>G115010002</p>  <p>KOMPRESÖR HAVA FİLTRESİ COMPRESSOR AIR FILTER ВОЗДУШНЫЙ ФИЛЬТР КОМПРЕССОРА</p>

<p>G101060003</p>  <p>YAKIT DEPOSU FUEL TANK ТОПЛИВНЫЙ БАК</p>	<p>G303010024</p>  <p>DİZEL KOMPRESÖR MUHAFAZA DIESEL COMPRESSOR HOUSING КОРПУС ДИЗЕЛЬНОГО КОМПРЕССОРА</p>	<p>G109020005</p>  <p>KAFES ORİNGİ VALVE CAP O-RING РЕЗИНОВАЯ ПРОКЛАДКА КЛАПАНА</p>	<p>G108090001</p>  <p>PİSLİK TUTUCU LINE FILTER ФИЛЬТР</p>
<p>G303010026</p>  <p>DİZEL MOTOR KAPLİN DIESEL ENGINE COUPLING МУФТА ДИЗЕЛЬНОГО ДВИГАТЕЛЯ</p>	<p>G109010012</p>  <p>CONTA TAKIMI GASKET KIT КОМПЛЕКТ ПРОКЛАДОК</p>	<p>G105020010</p>  <p>KOMPRESOR HAVA FİLTRESİ LASTİK CONTA COMPRESSOR AIR FILTER RUBBER GASKET РЕЗИНОВАЯ ПРОКЛАДКА ВОЗДУШНОГО ФИЛЬТРА КОМПРЕССОРА</p>	<p>G304120001</p>  <p>ELEKTRİK PANOSU 18.5 Kw ELECTRICAL PANEL 18.5 Kw ЭЛЕКТРИЧЕСКАЯ ПАНЕЛЬ 18,5 кВт</p>
<p>G104020001</p>  <p>ŞALTER KONTAK TRİFAZE SWITCH CONTACT THREE PHASE КОНТАКТ ПЕРЕКЛЮЧАТЕЛЯ ТРЕХФАЗНЫЙ</p>	<p>G104020002</p>  <p>ŞALTER KONTAK YILDIZ ÜÇGEN SWITCH CONTACT STAR TRIANGLE ПЕРЕКЛЮЧАТЕЛЬ КОНТАКТ ЗВЕЗДА ТРЕУГОЛЬНИК</p>	<p>G301070021</p>  <p>TENTE SACI AWNING SHEET IRON ТЕНТОВЫЙ ЛИСТ</p>	<p>G303030004</p>  <p>KLAPE KAFES UZUN VALVE CAP LONG КЛЕТКА КЛАПАНА ДЛИННАЯ</p>
<p>G303030003</p>  <p>KLAPE KAFES KISA VALVE CAP SHORT КЛЕТКА КЛАПАНА КОРОТКАЯ.</p>	<p>G104020003</p>  <p>EMNİYET SALTERİ SAFETY SWITCH ПРЕДОХРАНИТЕЛЬНЫЙ ВЫКЛЮЧАТЕЛЬ</p>	<p>G301070039</p>  <p>DİZEL ŞASE DIESEL CHASSIS ШАССИ ДИЗЕЛЬНОГО КОМПРЕССОРА</p>	<p>G301070032</p>  <p>ELEKTRİKLİ ŞASE ELECTRIC CHASSIS ШАССИ ЭЛЕКТРИЧЕСКОГО КОМПРЕССОРА</p>

<p>G521030001</p>  <p>ÇALPARA ÇEKVALF CHECK VALVE ОБРАТНЫЙ КЛАПАН ЧАЛПАРА</p>	<p>G508150002</p>  <p>KELEBEK VANA BUTTERFLY VALVE КЛАПАН-БАБОЧКА</p>	<p>G521010002</p>  <p>KIRMIZI ELEK BEZİ RED AERATION HOSE КРАСНАЯ СИТОВАЯ ТКАНЬ</p>	<p>G508150001</p>  <p>KÜRESEL VANA BALL VALVE ШАРОВОЙ КРАН</p>	<p>G521010001</p>  <p>SARI ELEK BEZİ YELLOW AERATION HOSE ЖЕЛТАЯ СИТОВАЯ ТКАНЬ</p>
<p>G521010003</p>  <p>SİLOBAS BOŞALTIMA HORTUMU BULK TRAILER DISCHARGE HOSE ШЛАНГ ДЛЯ СЛИВА ЦЕМЕНТА</p>	<p>G516010001</p>  <p>SİLOBAS MANOMETRESİ BULK TRAILER PRESSURE GAUGE МАНОМЕТР ЦЕМЕНТОВОЗА</p>	<p>G521020001</p>  <p>ÜST KAPAK CONTA TOP COVER GASKET ПРОКЛАДКА ВЕРХНЕЙ КРЫШКИ ЦЕМЕНТОВОЗА</p>	<p>G508110001</p>  <p>4" ALMAN TİP ALÜMİNYUM RAKOR 4" GERMAN TYPE ALUMINUM COUPLING 4" АЛЮМИНИЕВЫЙ СОЕДИНЕНИЕ НЕМЕЦКОГО ТИПА</p>	<p>G508110002</p>  <p>4" İÇTEN DİŞLİ ALÜMİNYUM RAKOR 4" ALUMINUM COUPLING 4" АЛЮМИНИЕВЫЙ ФИТИНГ С ВНУТРЕННЕЙ РЕЗЬБОЙ</p>
<p>G521030002</p>  <p>DİSKO ÇEKVALF CHECK VALVE ОБРАТНЫЙ КЛАПАН</p>	<p>G515010001</p>  <p>SEPARATÖR FİLTRESİ SEPARATOR FILTER ФИЛЬТР-СЕПАРАТОР</p>	<p>G116010006</p>  <p>EMNİYET VENTİLİ DİŞİ SAFETY VALVE (INTERNAL THREAD) ПРЕДОХРАНИТЕЛЬНЫЙ КЛАПАН ВНУТРЕННИЙ</p>	<p>G116010002</p>  <p>EMNİYET VENTİLİ ERKEK SAFETY VALVE (EXTERNAL THREAD) ПРЕДОХРАНИТЕЛЬНЫЙ КЛАПАН НАРУЖНАЯ</p>	<p>G521020002</p>  <p>KÜRESEL VANA CONTA (BÜYÜK) İÇ ÇAP 160 MM BALL VALVE SEAL (LARGE) INNER DIAMETER 160 MM УПЛОТНЕНИЕ (БОЛЬШОЙ) ВНУТ. ДИАМ. 160 MM</p>
<p>G521020003</p>  <p>KÜRESEL VANA CONTA (KÜÇÜK) İÇ ÇAP 102 MM BALL VALVE SEAL (SMALL) INNER DIAMETER 102 MM УПЛОТНЕНИЕ (МАЛЕНЬКИЙ) ВНУТ. ДИАМ. 102 MM</p>	<p>G521040001</p>  <p>KÜRESEL VANA İÇ GÖBEK BALL VALVE INNER CORE ШАРЫ ДЛЯ ШАРОВЫХ КРАНОВ</p>	<p>G521040002</p>  <p>MENHOL KARAĞI ALÜMİNYUM MANHOLE COVER ALUMINUM АЛЮМИНИЕВАЯ КРЫШКА ЛЮКА</p>	<p>G521040003</p>  <p>MENHOL KARAĞI DEMİR MANHOLE COVER IRON ЖЕЛЕЗНАЯ КРЫШКА ЛЮКА</p>	<p>G521040004</p>  <p>PİNÇ VANA PINCH VALVE ПНЕВМАТИЧЕСКИЙ ПЕРЕЖИМНОЙ КЛАПАН</p>
<p>G521040005</p>  <p>PİNÇ VANA LASTİĞİ PINCH VALVE RUBBER МАНЖЕТА ДЛЯ ПЕРЕЖИМНОГО КЛАПАНА</p>	<p>G521040006</p>  <p>PİNÇ VANA LASTİĞİ (DUDAKLI) PINCH VALVE RUBBER (LIPPED) ПАТРУБОК ПЕРЕЖИМНОГО КЛАПАНА</p>			

G112010001	G112010001	G119020001	G112020004	G112020002
				
BEİNEİ YENİ DİZEL MOTOR 4 Silindir	BEİNEİ YENİ DİZEL MOTOR 6 Silindir	DEUTZ STD PISTON FL912	DEUTZ STD KOL YATAK	DEUTZ DİZEL OTOMATİĞİ
BEINEI NEW DIESEL ENGINE 4 CYLINDER	BEINEI NEW DIESEL ENGINE 6 CYLINDER	PISTON FL 912	DEUTZ	DEUTZ FEED PUMP
4-ЦИЛИНДРОВЫЙ НОВЫЙ ДИЗЕЛЬНЫЙ ДВИГАТЕЛЬ BEINEI	6-ЦИЛИНДРОВЫЙ НОВЫЙ ДИЗЕЛЬНЫЙ ДВИГАТЕЛЬ BEINEI	ПОРШЕНЬ FL 912	ШАТУННЫЕ ВКЛАДЫШИ DEUTZ	ДИЗЕЛЬНАЯ АВТОМАТИКА DEUTZ
G112020003	G112020013 - G112020014	G112020028	G112020030	G112020031
				
DEUTZ STD ANA YATAK	DEUTZ SPZ KAYIŞ 9.5x1300 / 9.5x1075	DEUTZ GÖMLEK RAYNELİ	DEUTZ YAĞ MUSURU	DEUTZ YAĞ POMPASI
DEUTZ STD MAIN BEARING	DEUTZ SPZ BELT 9.5x1300 / 9.5x1075	DEUTZ CYLINDER WASHER	DEUTZ OIL SWITCH	DEUTZ OIL PUMP
ШАТУННЫЕ ВКЛАДЫШИ DEUTZ	РЕМЕНЬ DEUTZ SPZ 9.5x1300 / 9.5x1075	ЦИЛИНДРИЧЕСКАЯ РЕЙКА DEUTZ	ДАТЧИК МАСЛА DEUTZ	МАСЛЯНЫЙ НАСОС DEUTZ
G112020035	G112020037	G112020040	G112020044	G112020048
				
DEUTZ YAĞ RADYATÖRÜ	DEUTZ TÜRBİN	DEUTZ MANDAL	DEUTZ GÖMLEK-FL912 STD Ø100	DEUTZ SİLİNDİR ÜST KAPAK-FL912
DEUTZ OIL RADIATOR	DEUTZ TURBINE	DEUTZ SHEET IRON LATCH	DEUTZ SLEEVE-FL912 STD Ø100	DEUTZ CYLINDER HEAD FL912
МАСЛЯНЫЙ РАДИАТОР DEUTZ	ТУРБИНА DEUTZ	ЗАЩЕЛКА DEUTZ	ЦИЛИНДР DEUTZ-FL912 STD Ø100	ВЕРХНЯЯ КРЫШКА ЦИЛИНДРА DEUTZ-FL912
G112020053	G112020063	G112020075	G112020079	G114020001
				
DEUTZ KRANK-FL912	DEUTZ GEZİNTİ YATAĞI	DEUTZ EKSANTRİK MİLİ	BEINEI STOP SELENOİD	SEGMAN PİSTON Ø100 - (DEUTZ STD Ø100 PİSTON SEGMAN TAKIMI)
DEUTZ CRANKSHAFT FL912	DEUTZ THRUST WASHER	DEUTZ CAMSHAFT	BEINEI SOLENOID VALVE	DEUTZ PISTON RING Ø100
ВАЛ ДВИГАТЕЛЯ DEUTZ	ПУТЕВАЯ ЧАСТЬ DEUTZ	РАСПРЕДЕЛИТЕЛЬНЫЙ ВАЛ DEUTZ	BEINEI STOP СОЛЕНОИД	КОЛЬЦО ПОРШНЯ Ø100 - (DEUTZ STD Ø100 КОМПЛЕКТ ПОРШНЕВЫХ КОЛЬЦ)
G109010014	G115020002	G115020003	G109030003	G109030004
				
CONTA TAKIM DEUTZ FL912	DEUTZ MOTOR DİZEL FİLTRESİ	DEUTZ MOTOR YAĞ FİLTRESİ	KEÇE DEUTZ KRANK ÖN (DEUTZ KÜÇÜK KEÇE)	KEÇE DEUTZ KRANK ARKA (DEUTZ BÜYÜK KEÇE)
DEUTZ GASKET KIT	DEUTZ FUEL FILTER	DEUTZ OIL FILTER	DEUTZ OIL SEAL FRONT (DEUTZ SMALL SEAL)	DEUTZ OIL SEAL REAR (DEUTZ BIG SEAL)
КОМПЛЕКТ ПРОКЛАДОК DEUTZ FL912	ДИЗЕЛЬНЫЙ ФИЛЬТР ДВИГАТЕЛЯ DEUTZ	МАСЛЯНЫЙ ФИЛЬТР ДВИГАТЕЛЯ DEUTZ	МАЛЕНЬКИЙ ВОЙЛОК DEUTZ	БОЛЬШОЙ ВОЙЛОК DEUTZ

G104130001



ELEKTRİK MOTOR 18,5 kW

ELECTRICAL ENGINE 18,5 kW

ЭЛЕКТРОДВИГАТЕЛЬ 18,5 кВт

G104130002



ELEKTRİK MOTOR 22 kW

ELECTRICAL ENGINE 22 kW

ЭЛЕКТРОДВИГАТЕЛЬ 22 кВт

G104130003



ELEKTRİK MOTOR 30 kW

ELECTRICAL ENGINE 30 kW

ЭЛЕКТРОДВИГАТЕЛЬ 30 кВт

G210020038



18,5 kW ELEKTRİKLI MOTOR AYAĞI

18,5 kW ELECTRIC MOTOR STAND

ДВИГАТЕЛЬНАЯ НОГА 18,5 кВт.

G210020038



22 kW ELEKTRİKLI MOTOR AYAĞI

22 kW ELECTRIC MOTOR STAND

ДВИГАТЕЛЬНАЯ НОГА 22 кВт.

G210020038



30 kW ELEKTRİKLI MOTOR AYAĞI

30 kW ELECTRIC MOTOR STAND

ДВИГАТЕЛЬНАЯ НОГА 30 кВт.



18,5 kW ELEKTRİKLI MOTOR ÜST KAPAK

18,5 kW ELECTRIC MOTOR TOP COVER

ВЕРХНЯЯ КРЫШКА
ЭЛЕКТРОДВИГАТЕЛЯ 18,5 кВт



22 kW ELEKTRİKLI MOTOR ÜST KAPAK

22 kW ELECTRIC MOTOR TOP COVER

ВЕРХНЯЯ КРЫШКА
ЭЛЕКТРОДВИГАТЕЛЯ 22 кВт



30 kW ELEKTRİKLI MOTOR ÜST KAPAK

30 kW ELECTRIC MOTOR TOP COVER

ВЕРХНЯЯ КРЫШКА
ЭЛЕКТРОДВИГАТЕЛЯ 30 кВт



GLOBALTECH

MAKINA

future technology

Globaltech Makina İmalat San. Tic. Ltd. Şti

Büyükkayalık Osb Mah. Konya 2. Organize Sanayi Bölgesi
Lalehan Cad. No 23 Selçuklu / Konya

Telefon: +90 332 502 19 76 • **Faks:** +90 332 502 19 77

Email: info@globaltechmak.com

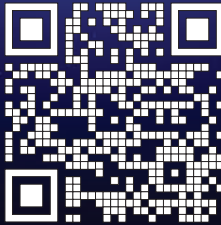

globaltechmak.com